

REVISION HISTORY			
REV	DESCRIPTION	INITIAL	DATE
1	NEW RELEASE	JAC	8/17/2010

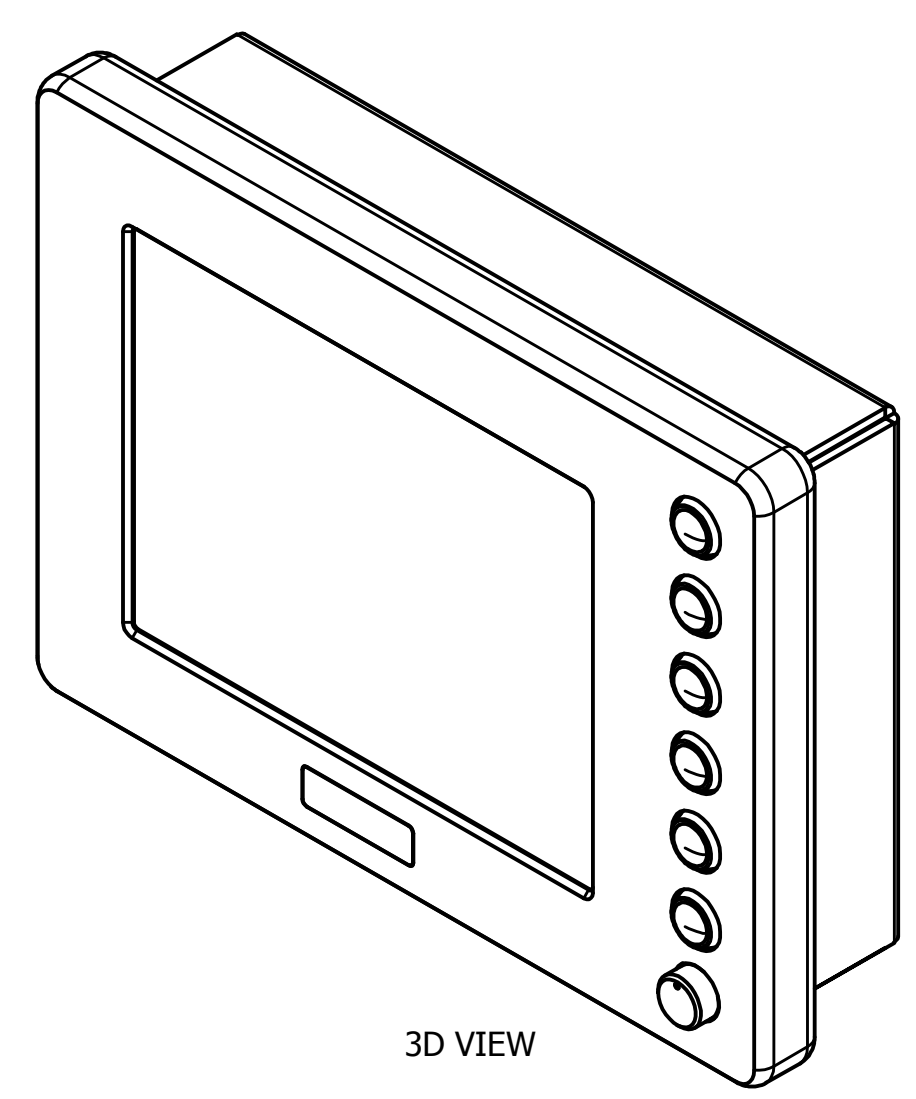

3D VIEW

DRAWN	ACarlton	8/17/2010	VARTECH SYSTEMS			
CHECKED						
QA			TITLE			
MFG			OUTLINE DRAWING, REAR EXIT, AW, 8.4"			
APPROVED			SIZE	TOLERANCES:	DWG NO	REV
USED ON	MATERIAL:		D	.XX = .01 .XXX = .005	482-0094-00	1
APPLICATION			FINISH:			SHEET 1 OF 1

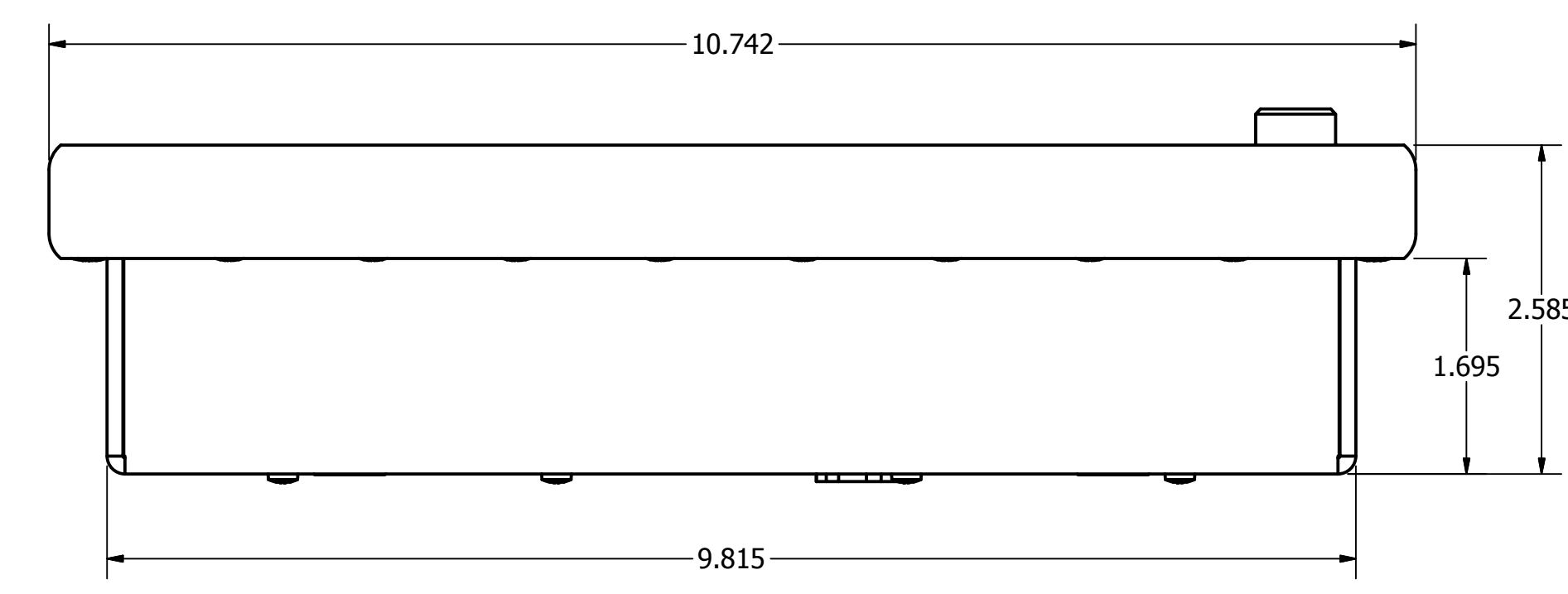
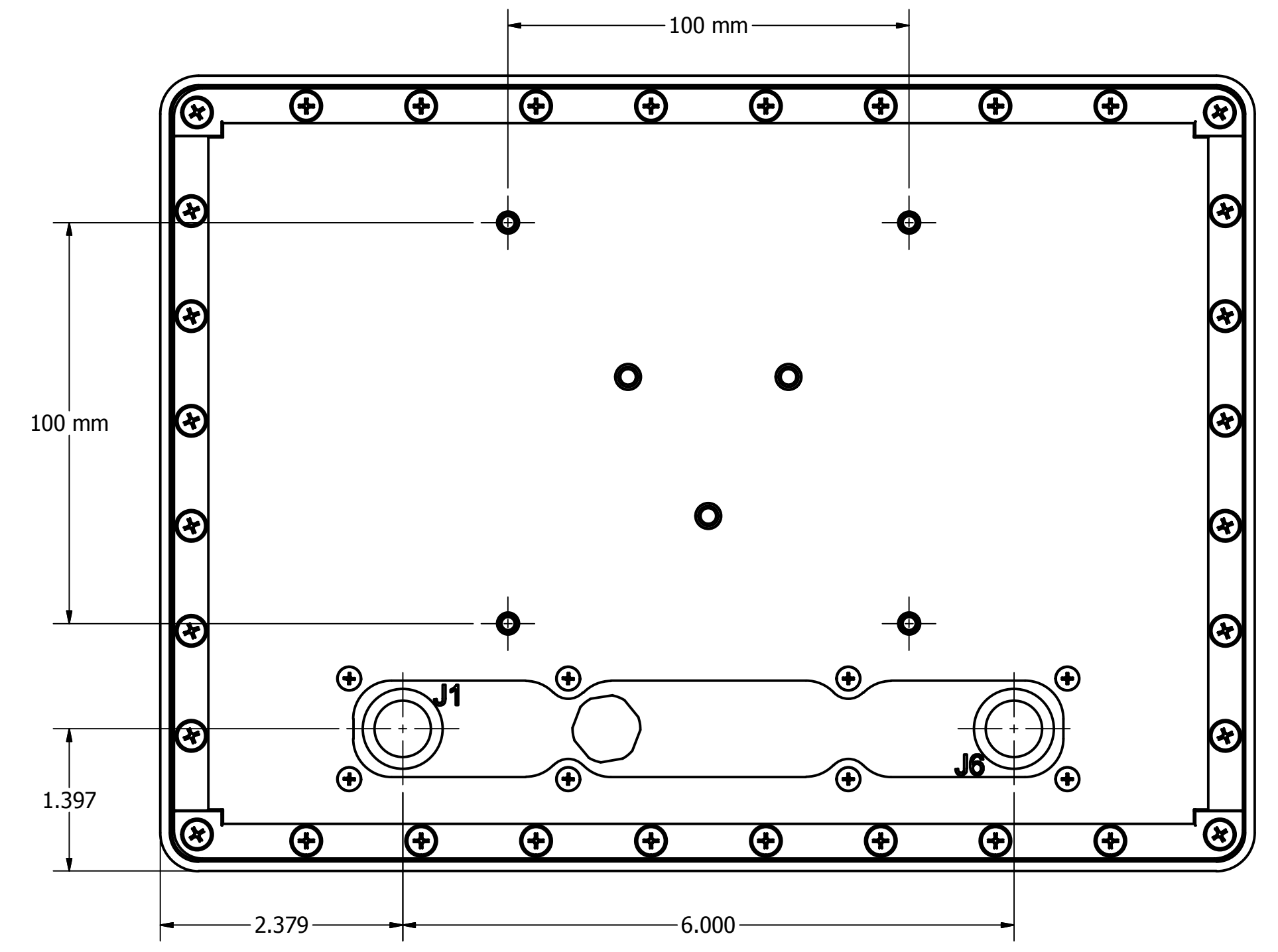
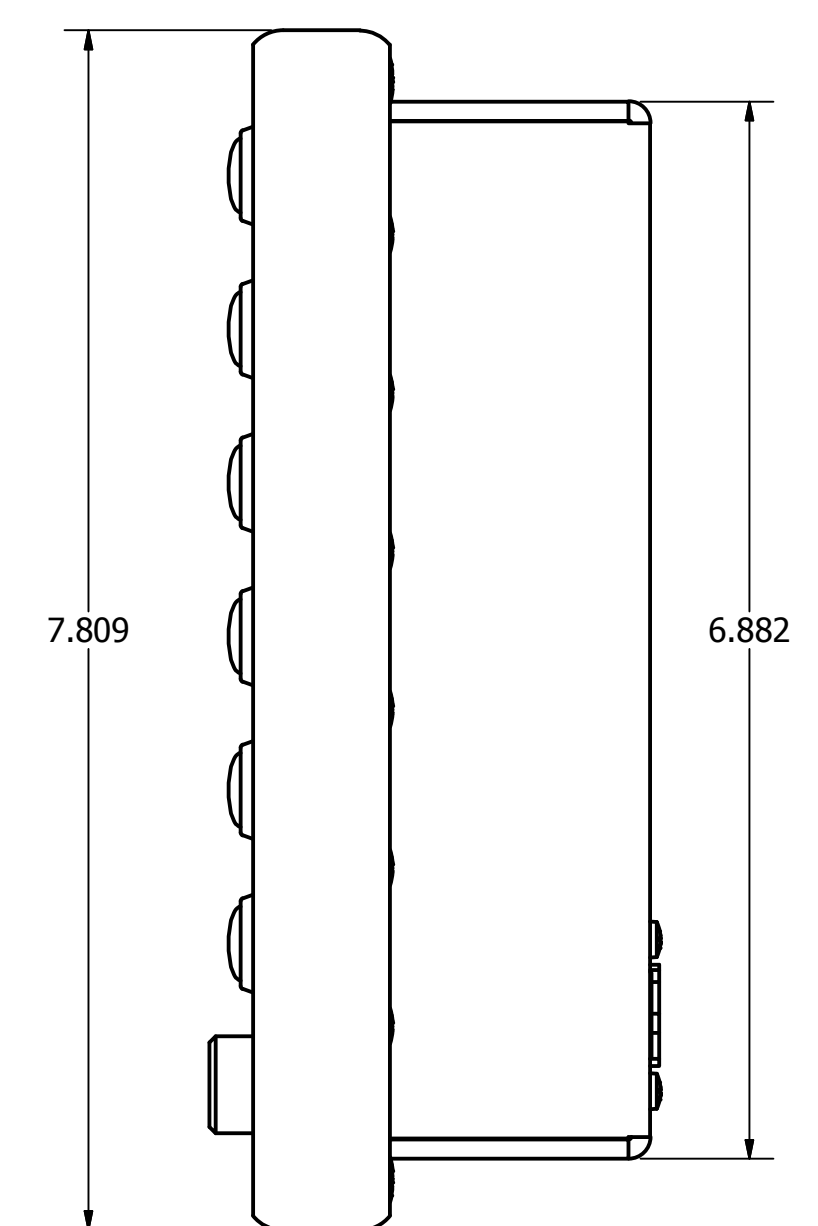
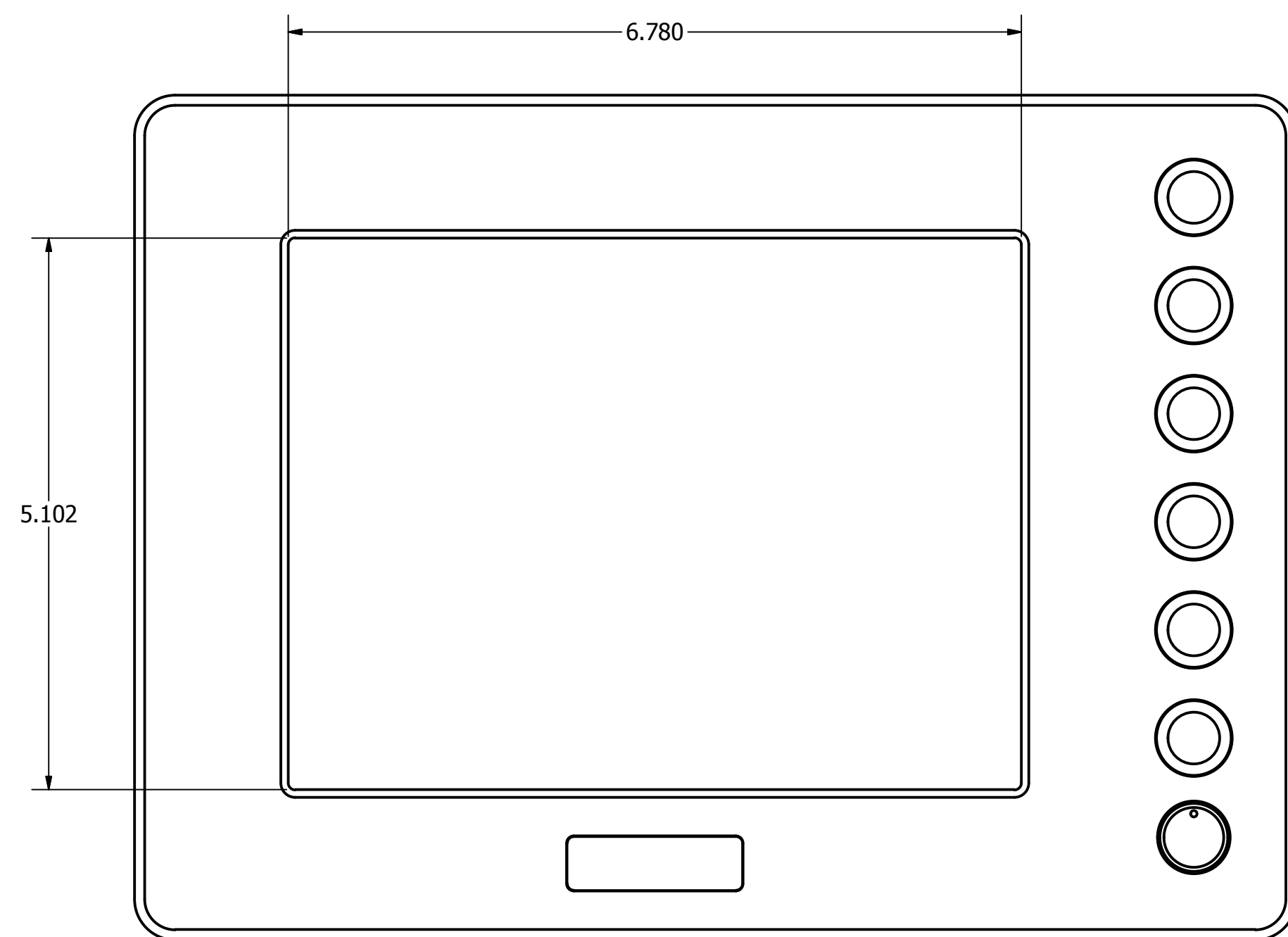

RAM Mount Type for VT084XA4 and VT104XA4

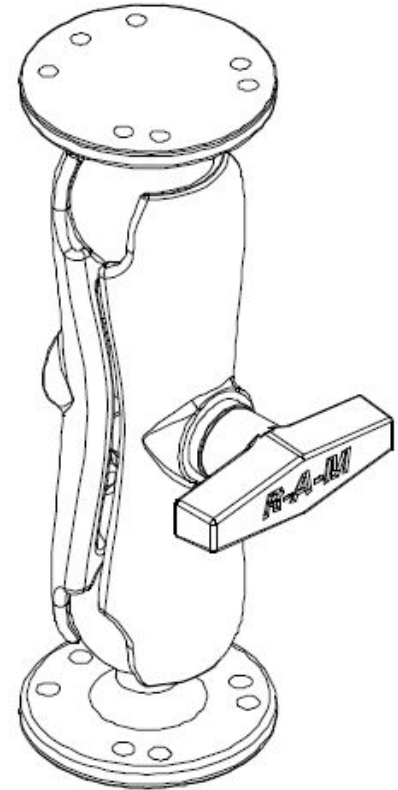
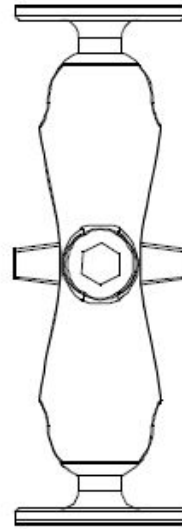
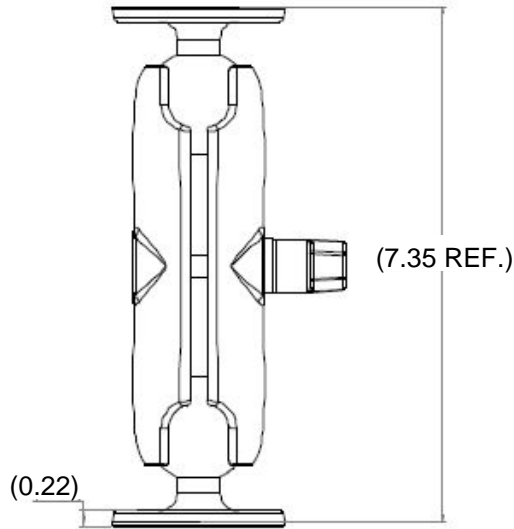

(0.91 RAD. 120 Degrees 3 Places)

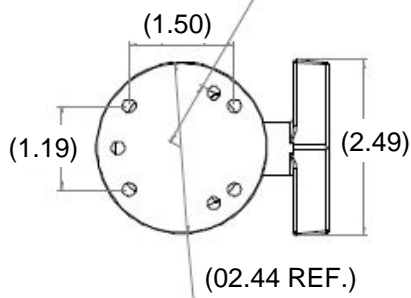

HEADQUARTERS
11529 Sun Belt Ct.
Baton Rouge, Louisiana 70809

Phone 800.223.8050
International 001.225.298.0300
Fax 225.297.2440

E-mail sales@vartechsystems.com
Website www.vartechsystems.com