

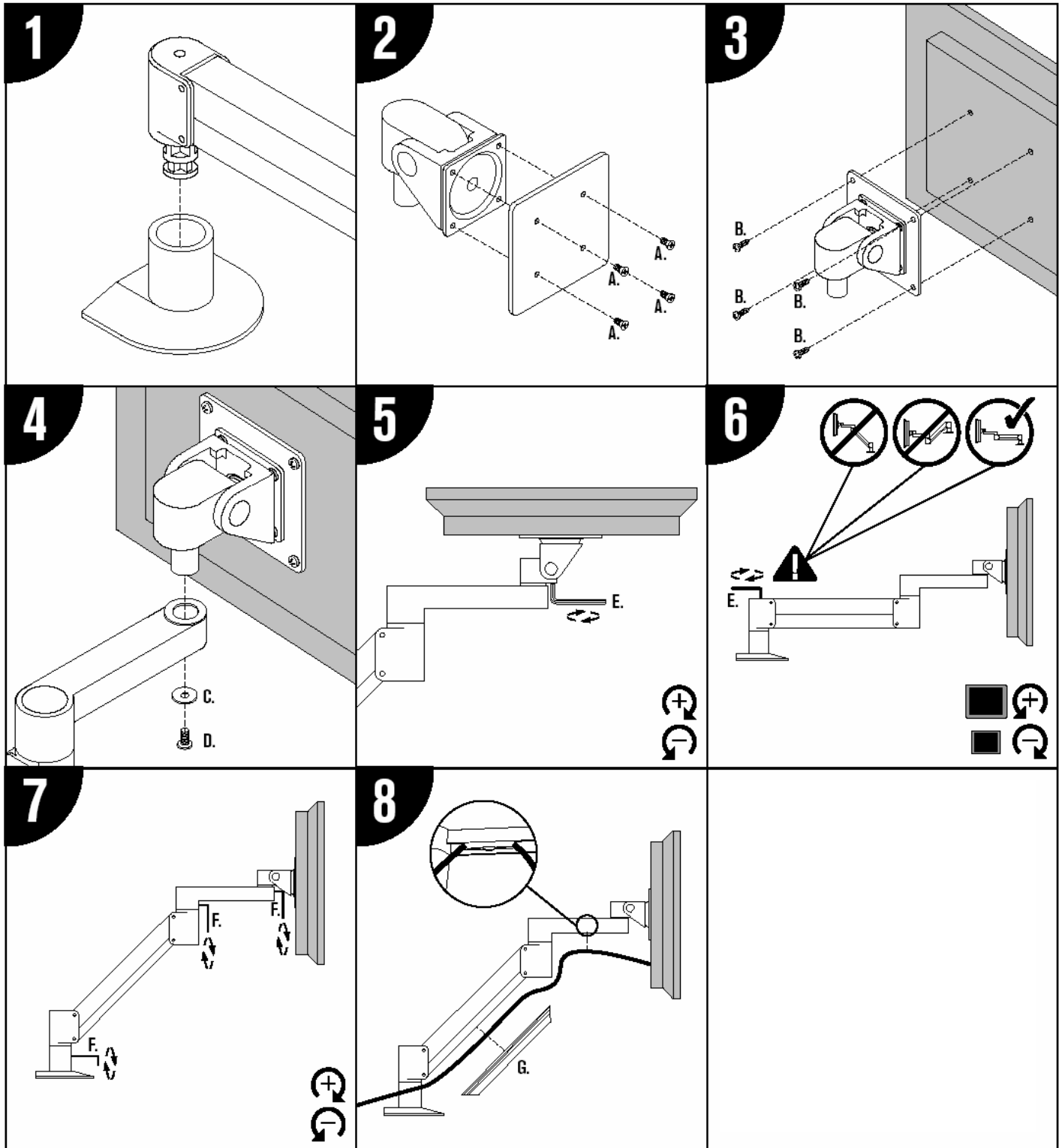

VT7000 Installation Guide









HEADQUARTERS
11529 Sun Belt Ct.
Baton Rouge, Louisiana 70809

Phone 800.223.8050
International 001.225.298.0300
Fax 225.297.2440

E-mail sales@vartechsystems.com
Website www.vartechsystems.com



VT7000 Installation Guide - Parts List

ITEM	DESCRIPTION / PART NO.	QUANTITY
A. 	10-32 x 3/8" (9.525mm) Philips Flat Head Screw 701164	4
B. 	M4-12 Philips Pan Head Screw 702096	4
C. 	Tilter Washer 704197	1
D. 	10-32 x 3/8" (9.525mm) Philips Pan Head Screw 700115	1
E. 	7/32" (5.563mm) Allen Wrench 701127	1
F. 	3/32" (2.388mm) Allen Wrench 700146	1
G. 	Cable Cap 102043-9.5A	1

HEADQUARTERS
11529 Sun Belt Ct.
Baton Rouge, Louisiana 70809

Phone 800.223.8050
International 001.225.298.0300
Fax 225.297.2440

E-mail sales@vartechsystems.com
Website www.vartechsystems.com



FLEXmount™ Installation Guide

Desk Clamp

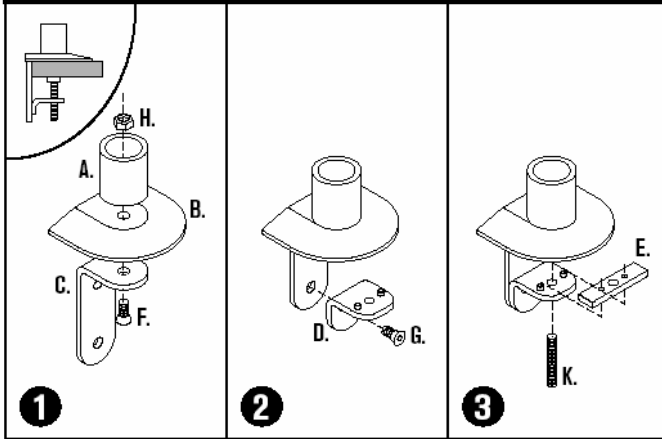

Thru-Desk

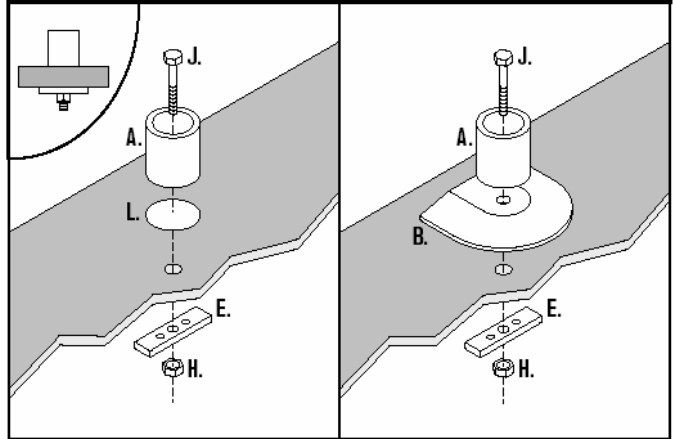

Wall Mount

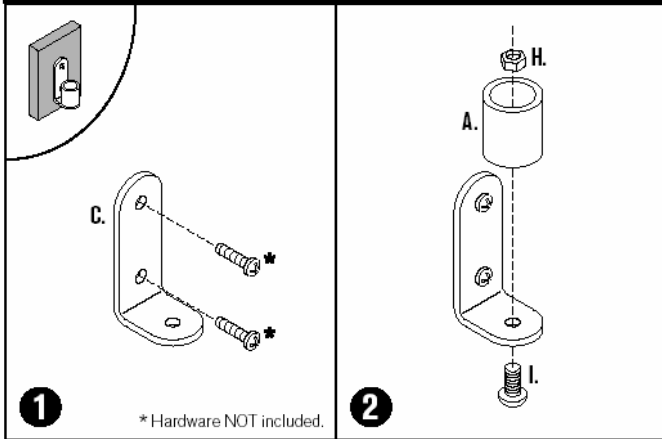

Reverse Wall Mount

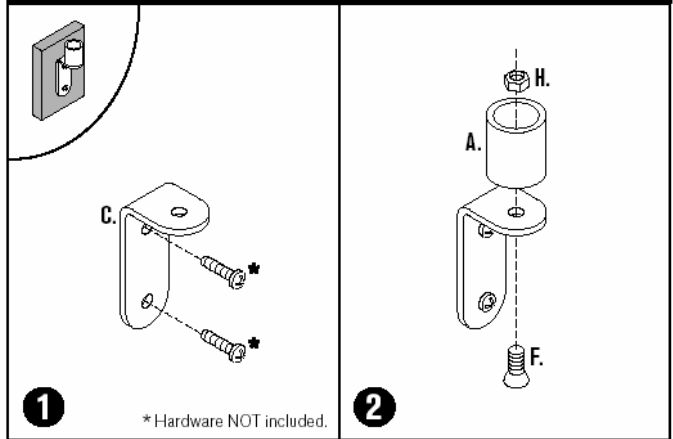

Grommet Hole

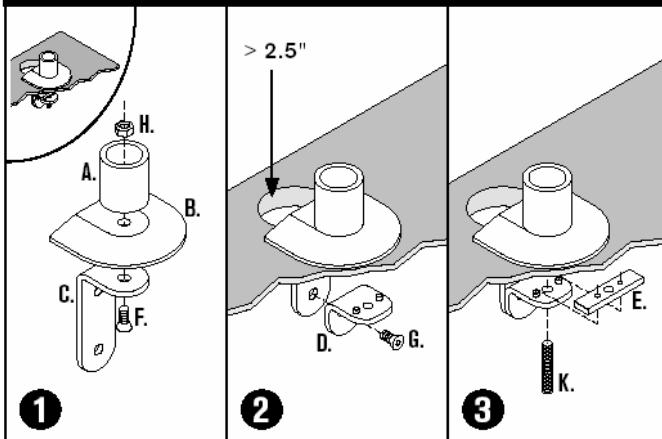

Side Bolt

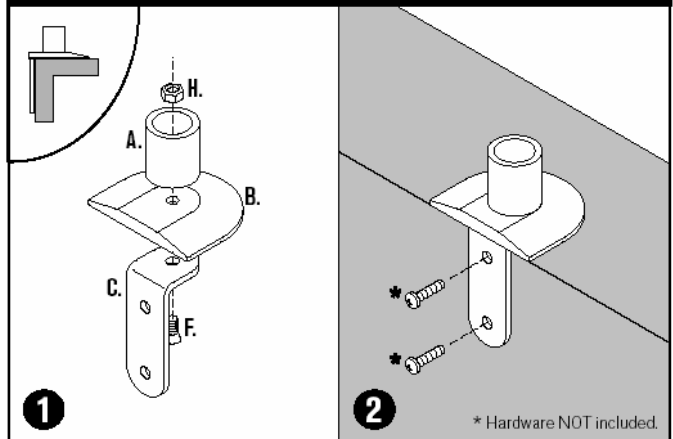





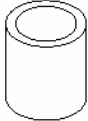
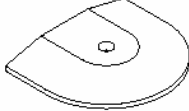
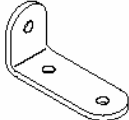

HEADQUARTERS
11529 Sun Belt Ct.
Baton Rouge, Louisiana 70809

Phone 800.223.8050
International 001.225.298.0300
Fax 225.297.2440

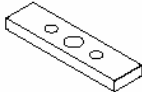
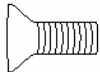
E-mail sales@vartechsystems.com
Website www.vartechsystems.com

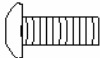
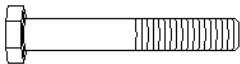
FLEXmount™ Installation Guide - Parts List

ITEM	DESCRIPTION / PART NO.	QUANTITY
A. 	Mount Column 401328 - Model 7000, Model 7045, Model 3500, Model 3545 8269 - Model 7500, iLift™, ArcView™ (9177-2 & 9177-3)	1
B. 	Base Plate 401417 - Model 7000, Model 7045, Model 3500, Model 3545 8321 - Model 7500, iLift™, ArcView™ (9177-2 & 9177-3)	1
C. 	Large "L" Bracket 701117 - Model 7000, Model 7045, Model 3500, Model 3545 702828 - Model 7500, iLift™, ArcView™ (9177-2 & 9177-3)	1
D. 	Small "L" Bracket 701116	1
E. 	3" (76.2mm) x 3/4" (19.05mm) x 1/4" (6.35mm) Rectangular Spacer 701544	1
F. 	3/8-16 x 1" (25.4mm) Flat Socket Cap Screw 701124 - Model 7000, Model 7045, Model 3500, Model 3545 701855 - 3/8-16 x 1-1/4" (31.75mm) - Model 7500, iLift™, ArcView™ (9177-2 & 9177-3)	1
G. 	3/8-16 x 7/8" (22.225mm) Flat Socket Cap Screw 701799	1
H. 	3/8-16 Nylon Stop Nut 701418	1
I. 	3/8-16 x 7/8" (22.225mm) Button Socket Cap Screw 701122	1
J. 	3/8-16 x 2-1/2" (63.5mm) Hex Head Bolt 700268	1
K. 	1/2-13 x 3" (76.2mm) Socket Set Screw 701126	1
L. 	Foam Pad (Included with Model 7000 only) 701120	1

HEADQUARTERS
 11529 Sun Belt Ct.
 Baton Rouge, Louisiana 70809

Phone 800.223.8050
International 001.225.298.0300
Fax 225.297.2440

E-mail sales@vartechsystems.com
Website www.vartechsystems.com