

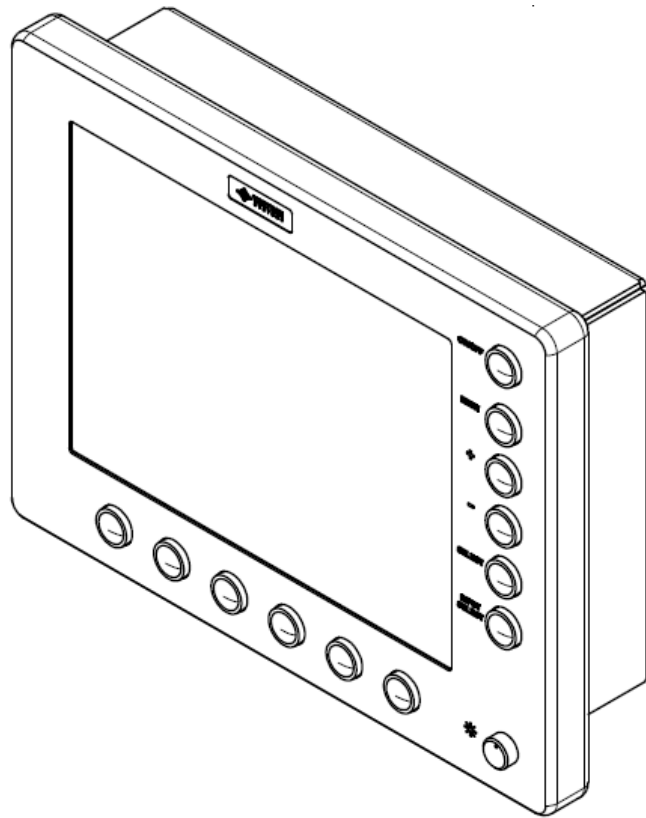

Solutions for Demanding Applications

VarTech Systems Inc.



All Weather Series LCD Monitors

VT121XAF

User's Guide

Read these instructions completely before attempting to operate your new LCD Color Display.

Table Of Contents			
	Page		Page
Section 1 Introduction		Section 4 Touchscreen	
1.0 Overview	3	4.1 Touch Screen Introduction	11
1.1 VT121XAF General Features	3	4.2 Touch Screen Installation	11
1.2 Product Safety Precautions	3		
Section 2 Display Setup		Section 5 Troubleshooting	
2.1 Inspection	4	5.1 General	12
2.2 Unpacking	4		
2.3 Included Parts	4	Section 6 Maintenance	
2.4 Installation Guidelines	4-5	6.1 Cleaning	13
2.5 Input Connections	6		
		Specifications	14
Section 3 Getting Started			
3.1 Adjusting the display	7	Mechanical Drawings	15
3.2 OSD Adjustments	8-10		
3.3 Function Buttons	10		

INTRODUCTION

SECTION 1

1.1 Overview

The VarTech All-Weather VT121XAF display includes waterproof, totally sealed, IP67 NEMA 6 LCD displays. This high resolution, sunlight readable LCD displays provide exceptional clarity, viewing angles, extensive operational temperatures (-40°C to +70°C), IP67 (NEMA 6) protection, and offer durable, 5-Wire, resistive touch screens.

1.2 VT121XAF General Features

- IP67 Fully Enclosed LCD
- Rugged Machined 6061 T6 Aluminum Enclosure
- Solid State LED Backlighting
- Optical Bonding (VBOND) front overlay (AR)
- Optional Resistive Touch Screens, standard and Armor
- VESA, Flush, RAM, and Panel Mounting Options
- Full Range Manual Dimming
- Push Button OSD (On-Screen Display)
- Six function buttons
- Military style connectors

1.3 Product Safety Precautions

- Ensure that sufficient space is available around the display to provide the circulation necessary for cooling.
- Ensure that the ambient air temperature will not exceed the specified maximum temperature.
- Do not attempt to service this display yourself. The rear chassis has a seal so that non qualified personnel will not expose themselves to dangerous voltages or other risks.
- To protect from electrical shock, unplug the display power supply from the wall before moving.
- Do not place any heavy objects on the power cords. Damage may cause electrical shock.
- Unplug the power supply from the wall or unit if one of the following conditions exists:
 - Power cord or plug is damaged or frayed.
 - The display does not operate normally when the operating instructions are followed.
 - The display has been dropped or the enclosure has been damaged.
 - The display exhibits a distinct change in performance, indicating a need for service.

DISPLAY SETUP

SECTION 2

2.1 Inspection of your VT121XAF All Weather Display

The Vartech VT121XAF All Weather display is supplied with different accessories depending on the model configuration purchased. Verify that the display and accessories are what were ordered. Contact your Vartech salesperson should there be any discrepancies.

2.2 Unpacking and setting up your VT121XAF All Weather Display

Before unpacking the product, inspect the shipping carton for damage. If damage is visible, immediately contact VarTech and request assistance. Otherwise, proceed with unpacking. Keep the original packing material in case you need to return the product for repair or transport it to another location. Use both the inner and outer packing cartons to provide adequate protection for a unit returned for service.

Your display monitor package will consist of all or some of the components listed below. Open shipping container and place all the components on a flat clean surface.

2.3 What is included with your VT121XAF All Weather Display

- Installation instructions and cutout template
- Panel Mount Screws
- Four VESA or RAM mounting screws
- Power cable and AC adapter if ordered
- Video cable for input ordered (VGA, DVI, BNC)
- Touch Interface Cable, Serial or USB (Optional when touch is installed)
- CDROM with Touch Screen Drivers (Optional when touch is installed)

2.4 Installation Guidelines

Panel Mounting Guidelines

Observe these guidelines when installing the monitor in a panel.

Cut supporting panels to specifications before installation. Take precautions so metal cuttings do not enter components already installed in the panel.

Supporting panels should be at least .125" thick in order to provide proper sealing against water and dust and to provide proper support.

Install the monitor into the panel be careful not to cut hand on metal. Use .125" thick gasket to ensure a watertight seal. Do not use an adhesive.

Tighten the provided bolts. Do not over tighten as that can damage the helicoil inserts.

VESA Mounting Guidelines

The VESA-mount option is used to install the monitor on an articulated arm using an optional bracket. For a list of available mounts, please contact your Vartech salesperson.

Mounting Guidelines

Observe these guidelines when installing the monitor on an arm.

The mounting surface and the mounting arm must be strong enough to support both the monitor and the mounting hardware.

The interface between the arm and the monitor must meet VESA FPMPMI 100 mm standards.

The mounting location must provide adequate clearance for positioning and moving the adjustable unit and routing cables.

Mount the Monitor on a VESA Interface

Follow these steps to mount the monitor on a VESA interface.

1. Mount the arm to the VESA interface with screws, bolts, or clamps so the monitor cannot tip.
2. Align the monitor over the arm and insert four supplied screws through the arm bracket and into the monitor.

RAM Mounting Guidelines

RAM is the only universal ball-and-socket system that holds excessive amounts of weight in high vibration applications for military, commercial and private use.

Mounting Guidelines

Observe these guidelines when installing the monitor on the provided RAM.

The mounting surface must be strong enough to support both the monitor and the RAM.

The mounting location must provide adequate clearance for positioning and moving the adjustable unit and routing cables.

Follow these steps to mount the monitor on a RAM.

1. Mount the Base plate to the mounting surface where the monitor is intended to be permanently mounted
2. Mount the Shaft to the RAM interface by prying open the socket and slipping over the mounting ball.
3. Align the RAM monitor plate, attach using the supplied screws into the 3 RAM mounting holes (triangular pattern)
4. Loosen the socket and slip the ball into the socket. Secure in place by tightening the socket.

Mechanical Drawings		
Model	Description	Page(s)
VT121XA4F	VESA/RAM Mount Drawing	15

2.5 Input Connections



Input Assembly

Connections

Follow these steps to connect the monitor to an analog video source.

1. Connect one end of the power input cable to J1 and the other end to the 24VDC source.
2. Connect one end of the VGA, USB touch, and Function button output cable to J2 and the other cable end to the VGA and two USB ports of the computer.

J1 Pin Assignments

PIN NO.	COLOR	DESCRIPTION
A	RED	+V
B	BLACK	RETURN
C	GREEN	CHASSIS GROUND

J2 Pin

P1	COLOR	DESCRIPTION
1	RED	RED SIGNAL
2	GREEN	GREEN SIGNAL
3	BLUE	BLUE SIGNAL
4	PURPLE	GROUND
5	ORANGE	RED GROUND
6	YELLOW	GREEN GROUND
7	GRAY	BLUE GROUND
8	BROWN	HORIZONTAL SYNC
9	WHITE	VERTICAL SYNC
10	BLACK	SYNC RETURN

Assignments

11	RED	+5V
12	WHITE	D (-)
13	GREEN	D +
14	BLACK	GROUND
15		
16		
17	RED	+5V
18	WHITE	D (-)
19	GREEN	D +
20	BLACK	GROUND
21		
22		

VGA Connections

USB Touch output Pins 11 to 14

GETTING STARTED

SECTION 3

3.1 Adjusting the display







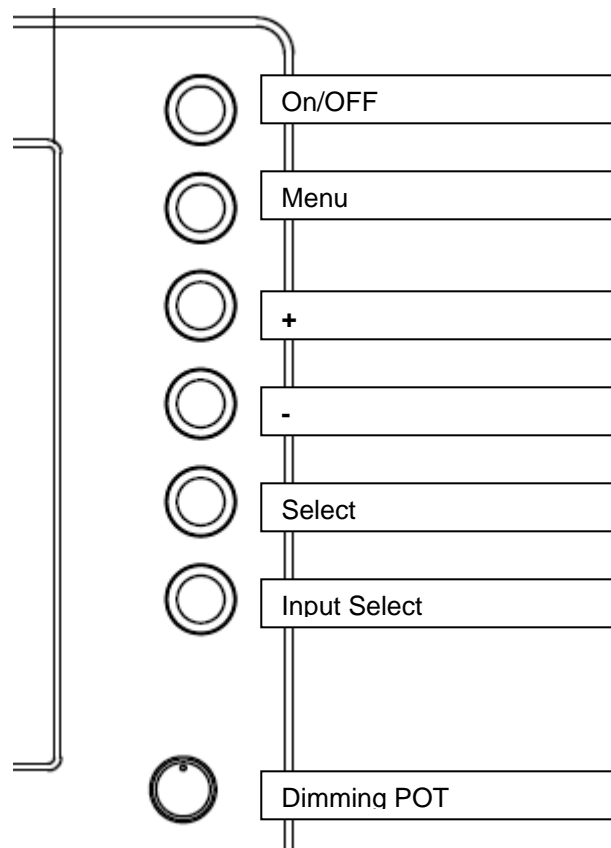









Set the monitor type





































The VT121XAF monitor is ***not*** plug n play compatible and require initial setup to begin operation













1. Ensure video and power cables are connected and secure and connected to the source
2. Power on the monitor
3. Toggle through the input select button until your video source is labeled and the video is showing
4. Adjust geometry of screen if necessary by using the advanced On-screen display. Activate the OSD
By pushing the MENU button, move to the necessary sub menus by using the +/- keys and entering select
5. Make adjustments and save by exiting the menu
6. Once the initial setup is complete you will not be required to redo



3.2 OSD Adjustments

		Selection page	
		Select input source ▶	
			Select input source to Analog RGB
			Select input source to DVI
			Select input source to S-Video 1
			Select input source to Composite 1
			Select input source to S-Video 2 (No function now)
			Select input source to Composite 2 (No function now)
		Auto Source Seek	ON – Auto source select always enable OFF – Disable auto source select function
		Video system selection* ▶	
			Select Auto video system detection
			Select PAL video system
			Select PAL M video system
			Select NTSC video system
			Select NTSC 4.43 video system
			Select SECAM video system
		Wide screen mode information display#	Select the input mode (1280 / 1360 / 1366 / 1368) to recognize and display the correct input signal information display on the OSD menu. 1280 : 1280x768 1366: 1366x768 1360 : 1360x768 1368: 1368x768

	Exit	Exit the OSD menu and save the settings
Brightness and Contrast		
	Brightness	Increase/decrease brightness level. Press – or + (-  +) Total : 256 steps
	Contrast	Increase/decrease panel contrast level. Press – or + (-  +) Total : 192 steps
	Saturation*	Increase/decrease hue level. Press – or + (-  +) Total : 256 steps
	Hue*	Increase/decrease saturation level Press – or + (-  +) Total : 128 steps
	Exit	Exit the OSD menu and save the settings
Color		
	Auto RGB Calibration#	<input checked="" type="checkbox"/> Yes <input type="checkbox"/> No
	Color Temperature ▶	(Adjust the warmth of the image displayed. The higher temperature the coolest image looks like. The lower temperature the warmest image looks like.)
		Adjust red color level Press – or + (-  +) Total :128 steps Adjust green color level Press – or + (-  +) Total : 128 steps Adjust blue color level Press – or + (-  +) Total : 128 steps Press SEL UP/DN button to select item
	4200K	Set the color temperature to 4200K
	5000K	Set the color temperature to 5000K
	6500K	Set the color temperature to 6500K
	7500K	Set the color temperature to 7500K
	9300K	Set the color temperature to 9300K
	Gamma adjustment ▶	Adjust Gamma settings (0.4 / 0.6 / 1.0 / 1.6 / 2.2)
	0.4	Select Gamma to 0.4
	0.6	Select Gamma to 0.6
	1.0	Select Gamma to 1.0
	1.6	Select Gamma to 1.6
	2.2	Select Gamma to 2.2
	Exit	Exit the OSD menu and save the settings
Position#		
	Auto setup	Auto adjust the positions, phase, frequency <input checked="" type="checkbox"/> Yes <input type="checkbox"/> No
	Frequency	Adjust the image horizontal size
	Phase	Fine tune the data sampling position (adjust image quality)
	Image Horizontal Position	Use +/- to move the image horizontally Press – or + (-  +)
	Image Vertical	Use +/- to move the image vertically Press – or + (-  +)
	Exit	Exit the OSD menu

Utilities		
		OSD setting ▶
		OSD Timeout : 0 / 10 / 20 / 30 / 40 / 50 / 60 seconds (Always on when set to 0) Press – or + (-  +)
		OSD menu horizontal position Press – or + (-  +)
		OSD menu vertical position Press – or + (-  +)
		Load Factory Default Initialize the setting stored in non-volatile memory
		Sharpness Adjust sharpness level Press – or + (-  +) Total : 49 steps
		Exit Exit the OSD menu
 Exit the OSD menu		

* - Function in Video mode only

- Function in ARGB mode only

Items marked ▶ have sub menus.

Exit the OSD menu to save the setting chosen

Adjust the Brightness

Use the dimming potentiometer located on the front bottom right corner of the display to adjust the brightness level of the LED backlights.

3.3 Function Buttons

The Function Button USB output codes are per the information below.



F1

F2

F3

F4

F5

F6

TOUCHSCREEN

SECTION 4

4.1 Introduction

Touch screens are a common means to interface operator inputs to a system. The universal standard of Windows GUI (Graphical User Interface) has significantly increased the use of touch screens.

The Vartech All Weather series offers two styles of 5 wire resistive technologies. The styles are standard resistive and the more durable Armor resistive touch.

4.2 Installation

All Vartech Systems displays configured with a touch screen are supplied with a CDROM which includes user manuals, application software, and drivers for various operating systems. Insert the supplied CDROM into a CDROM drive and follow the installation instructions that will appear on the screen.

Technical support is available by contacting Vartech Systems customer support at 800-223-8050.

TROUBLESHOOTING

SECTION 5

5.1

General

A general guide to troubleshooting a flat panel display system it is worth considering the system as separate elements, such as: Controller (jumpers, PC settings) Panel (controller, cabling, connection, panel, PC settings) Backlight (inverter, cabling, backlight tubes) Cabling Computer system (display settings, operating system) Through step by step cross checking with instruction manuals and a process of elimination to isolate the problem it is usually possible to clearly identify the problem area.

No image:

If the panel backlight is not working it may still be possible to just see some image on the display. A lack of image is most likely to be caused by incorrect connection, lack of power, failure to provide a signal or incorrect graphic card settings.

Image position:

If it is impossible to position the image correctly, i.e. the image adjustment controls will not move the image far enough, then test using another graphics card. This situation can occur with a custom graphics card that is not close to standard timings or if something is in the graphics line that may be affecting the signal such as a signal splitter (please note that normally a signal splitter will not have any adverse effect).

Image appearance:

A faulty panel can have blank lines, failed sections, flickering or flashing display, incorrect graphics card refresh rate, resolution or interlaced mode will probably cause the image to be the wrong size, to scroll, flicker badly or possibly even no image. Incorrect jumper settings on the controller may cause everything from total failure to incorrect image. CAUTION: Do not set the panel power input incorrectly. Sparkling on the display: faulty panel signal cable.

Backlight:

Items to check include: Power input, Controls, Inverter and Tubes generally in this order. If half the screen is dimmer than the other half: Check cabling for the inverter. For a specific backlight tube check the AC pins orientation (CAUTION: Never reverse any DC power pins). Also: If adjusting brightness control has no effect the chances are that the VR rating or method of adjusting brightness is not compatible or correctly connected to the inverter. If system does not power down when there is a loss of signal

Continued failure:

If unit after unit keeps failing consider and investigate whether you are short circuiting the equipment or doing something else seriously wrong.

Generally after common sense issues have been resolved we recommend step by step substitution of known working parts to isolate the problem.

MAINTENANCE

SECTION 6

6.1 Cleaning

Occasionally clean the display panel and cabinet with a soft cloth dampened (not soaked) with a mild (non-abrasive) glass cleaner. Keep turning a fresh side of the cloth toward the screen surface to avoid scratching it with accumulated grit.

Note: The solvent should be applied only to the cloth, and not directly on the monitor screen.

Do not use paper products as they may scratch the surface. To minimize the risk of abrasion, allow the screen to stand dry. Special care should be taken when cleaning a touch screen or polycarbonate shield that is installed over the screen. Abrasive and certain chemical cleaners can easily damage the surface. Never use alcoholic or ammoniac cleaners to clean the polycarbonate shield or a touch screen.

Note: For best results cleaning a monitor with the optional antireflective tempered glass display shield, a solution of denatured alcohol is recommended to thoroughly clean the display.

Replacing a Line Cord

To avoid shock and fire hazards, the monitor's power cord should be replaced if the insulation becomes broken or if it develops a loose internal connection.

Other Maintenance

Qualified service personnel should perform all maintenance, except for the power cord replacement described above.

SPECIFICATIONS

ENGINEERING SPECIFICATIONS – VT121XAF	
Panel Size	12.1" (31cm)
Type	Active Matrix Color Thin Film Transistor (TFT)
Native Panel Resolution	XGA
Pixel Format	1024 (H) x 768 (V)
Pixel Pitch	0.3075 (H) x 0.3075 (V) mm
Pixel Arrangement	RGB (Red dot, Green dot, Blue dot) vertical stripe
Dot Pitch	0.1025 (H) x 0.3075 (V) mm
Active Display Area	9.685" x 7.264" 246.0mm x 184.5mm
Viewing Angle (Left/Right)	80/80° (typ.)
Viewing Angle (Up/Down)	80/60° (typ.)
Color Gamut	40% (typ.)
Brightness	1000 Nits (typ.)
Contrast Ratio	600:1 (typ.)
Dimming Ratio	5000:1 (min.)
Response Time	25ms (typ.)
Back Lights	1 LED Rail rated 70,000 Hrs.
Input Connectors	Power D38999/24WA98PN
	VGA, USB, Function MS27468T13B35P
Colors Supported	16,777,216 (8-bit input)
Video Input	Analog 0.7v p-p, TTL
Sync	Separate H & V, Combined, SOG
Input Voltage	9 to 36VDC (12VDC typ.)
Power consumption	32 Watts (40 Watts with heater)
Temperature	Operating: -20 to 70°C (optional -40 to 70°C)
	Storage: -40 to 75°C
Humidity	Operating/Storage: 0 to 100 %NC
Operating Altitude	Operating: Up to 10,000 ft
	Storage: Up to 45,000 ft

PAGE INTENTIONALLY LEFT BLANK

Mechanical Drawings On The Following Pages

VARTECH SYSTEMS INC.

HEADQUARTERS

6399 Amp Drive, Clemmons, NC 27012

Toll-Free: 800.223.8050

International Phone: 001.225.298.0300

Fax: 225.297.2440

E-mail: sales@vartechsystems.com

www.vartechsystems.com

01.14.2011

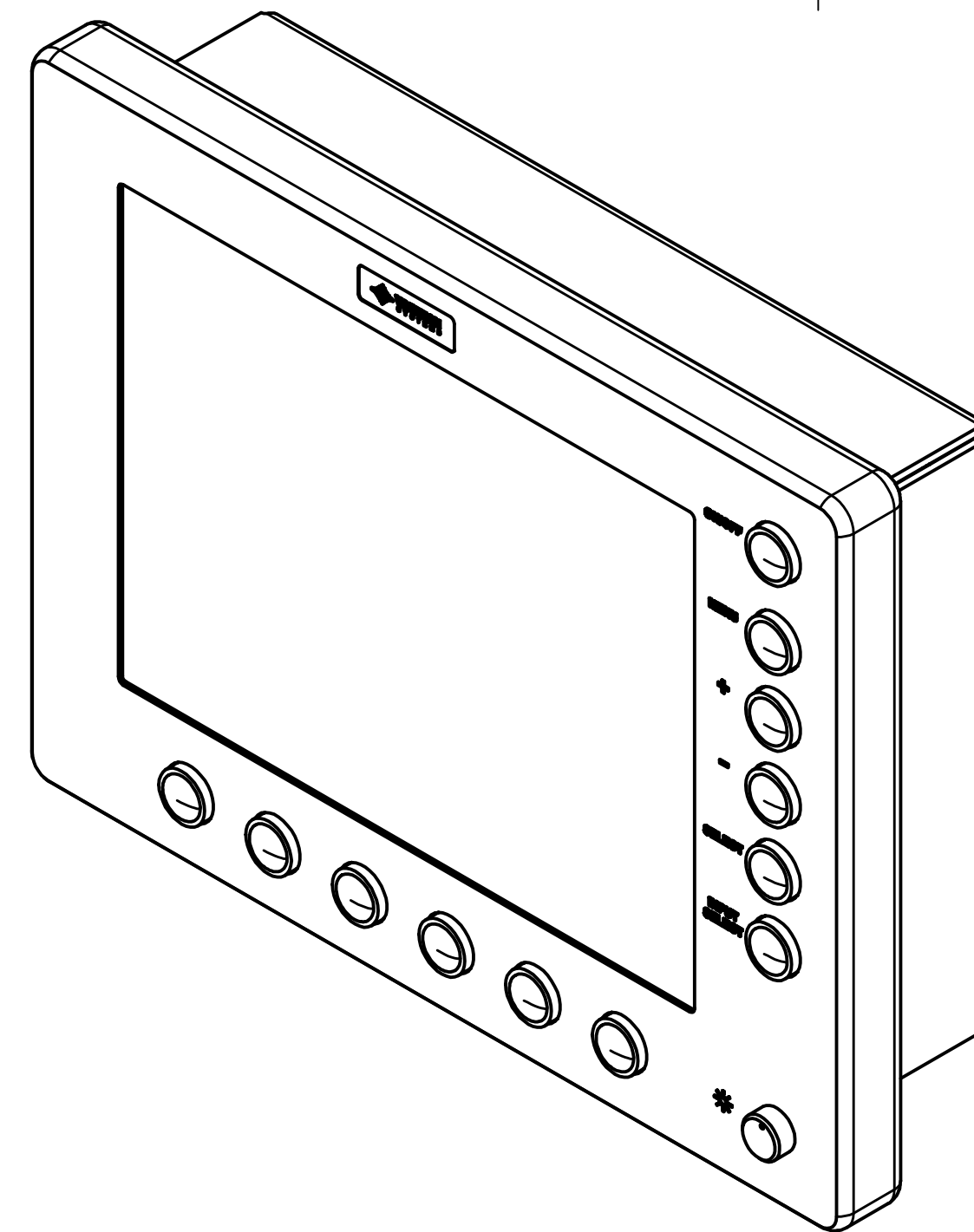
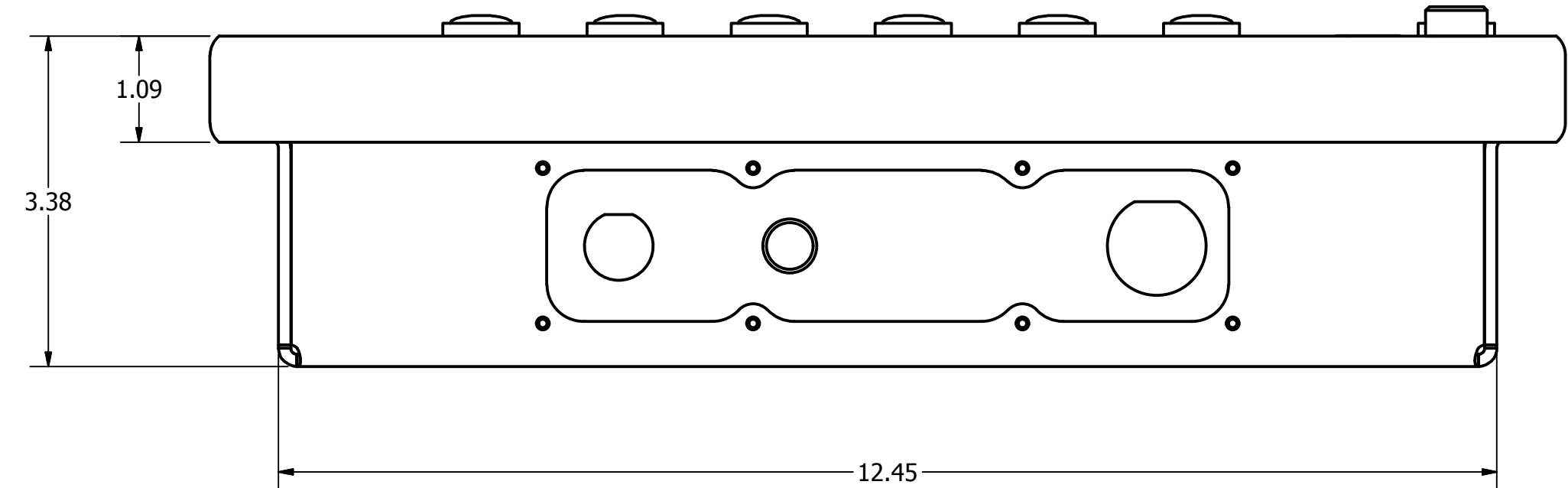
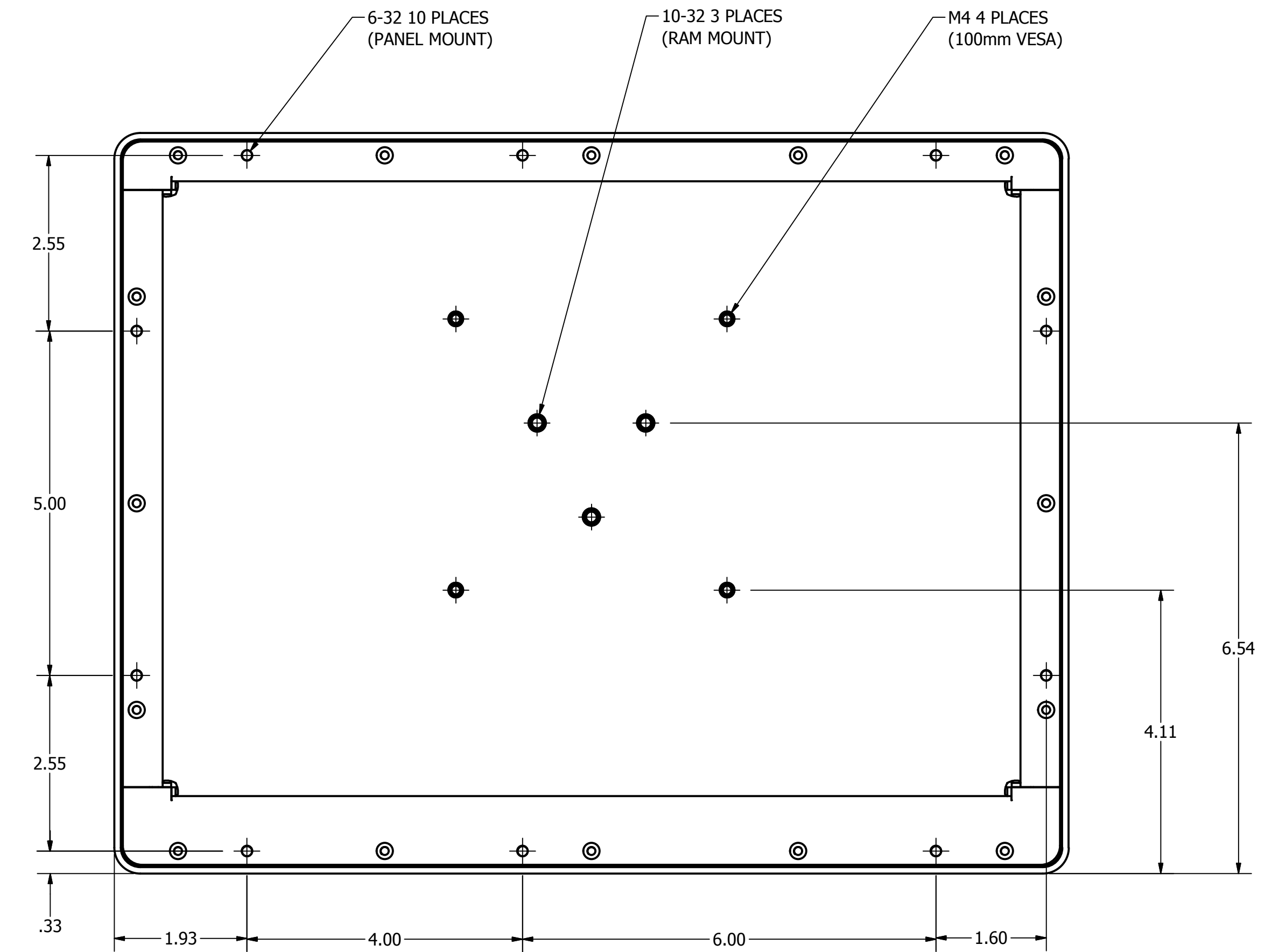
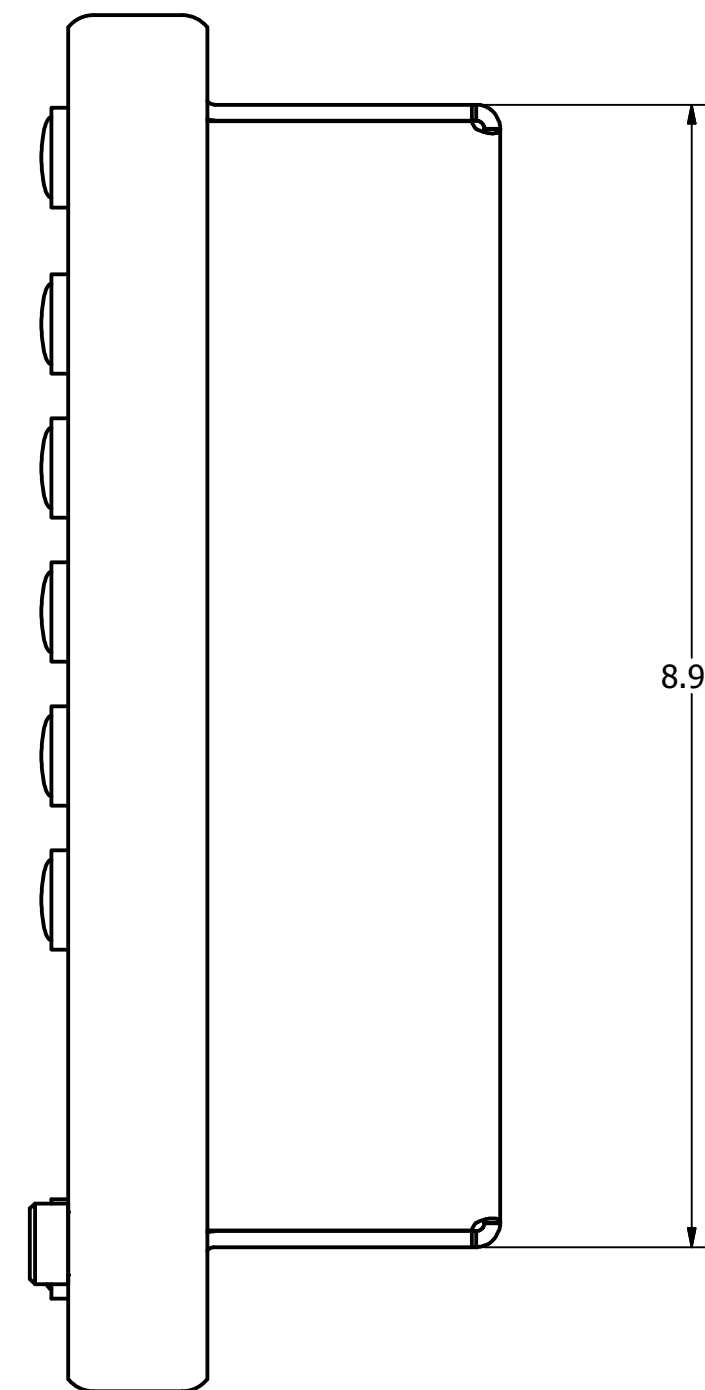
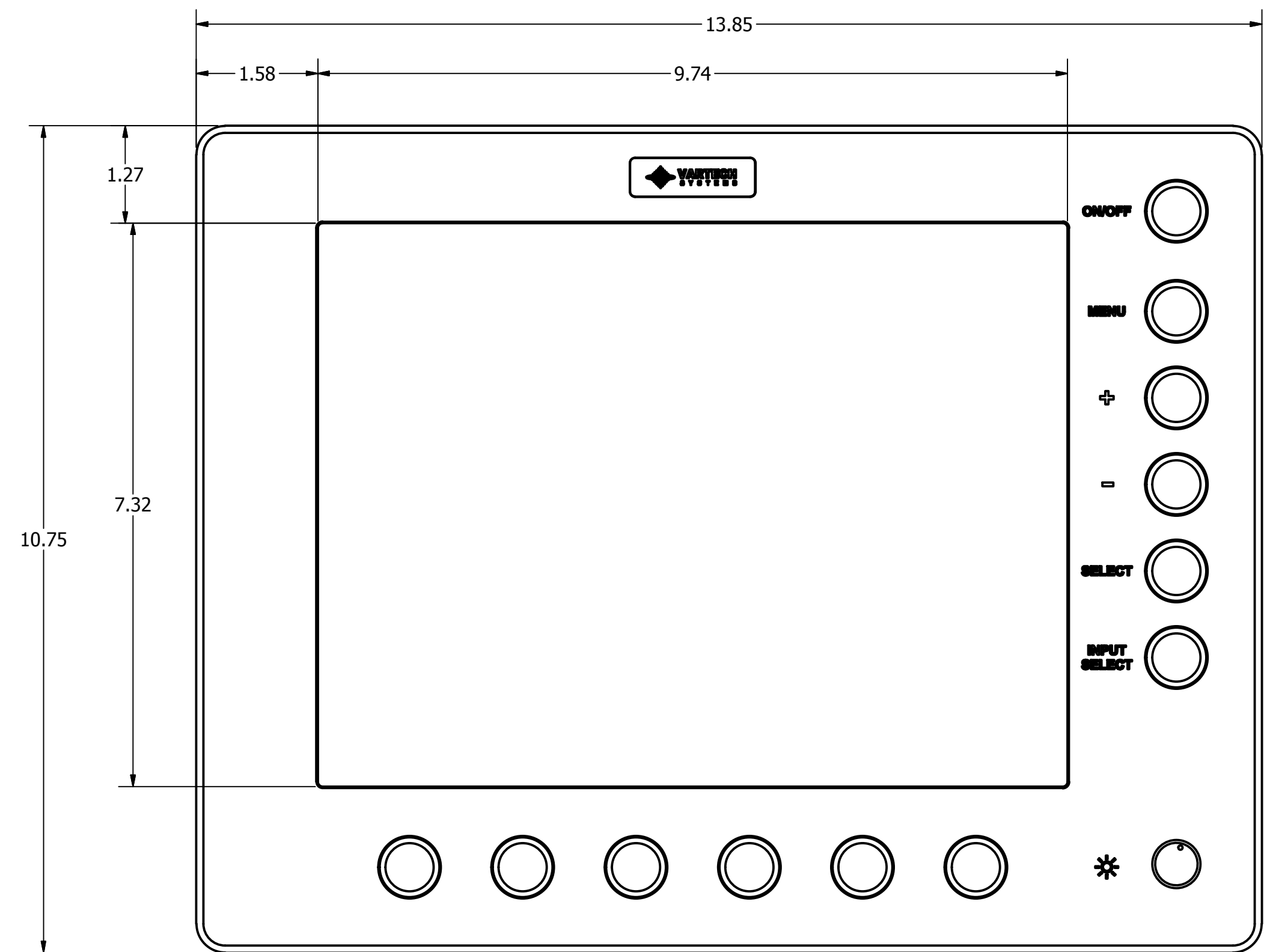

DRAWN	TFK	9/3/2010	 VARTECH SYSTEMS		
CHECKED					
QA			VT121XAF GEN 3		
MFG					
APPROVED					
USED ON	MATERIAL:		SIZE D TOLERANCES: .XX = .01 .XXX = .005 FINISH:	DWG NO 601-0370-R1	REV
APPLICATION			SHEET 1 OF 1		