

REVISION HISTORY			
REV	DESCRIPTION	INITIAL	DATE
1	NEW RELEASE	JAC	5/26/2010

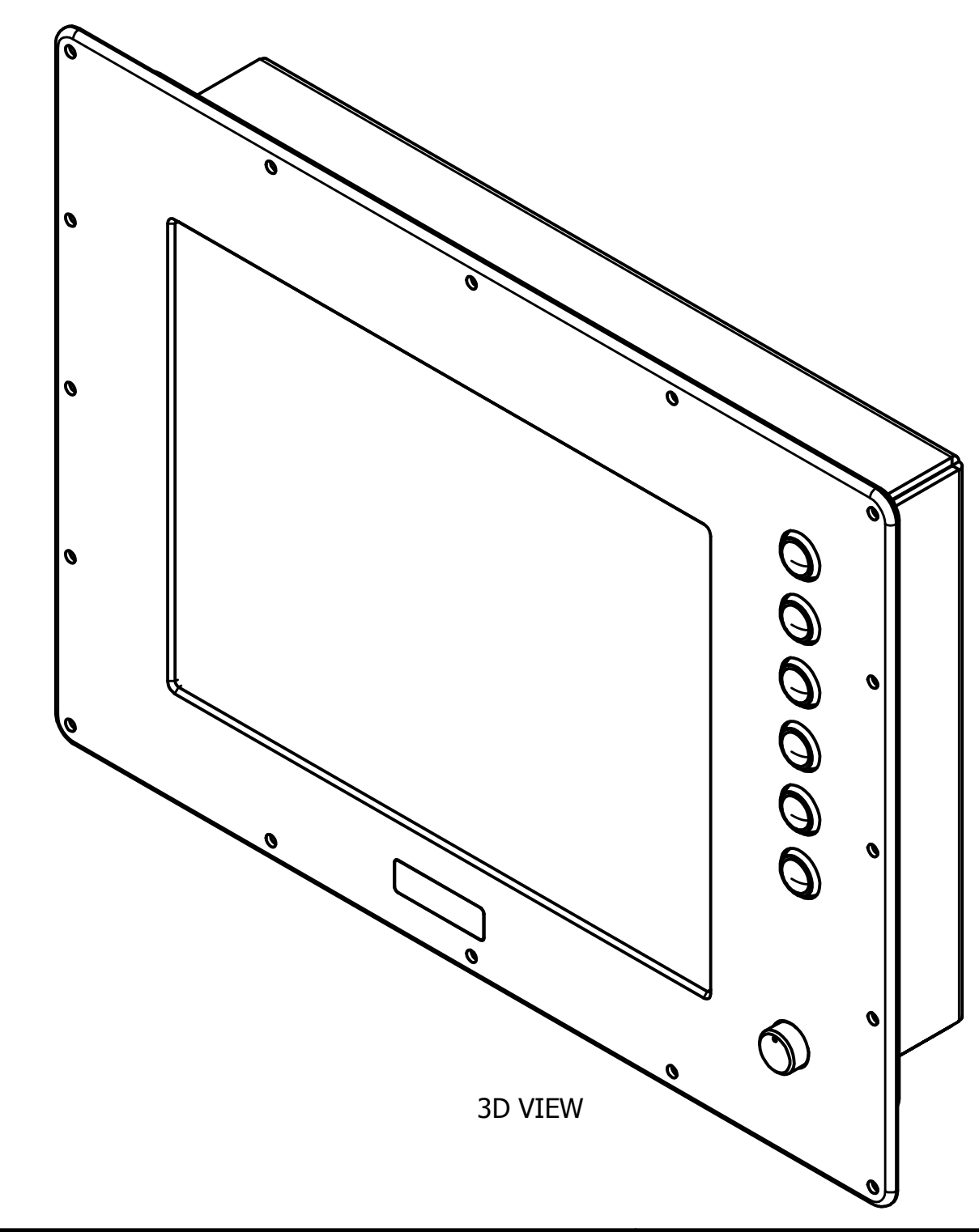
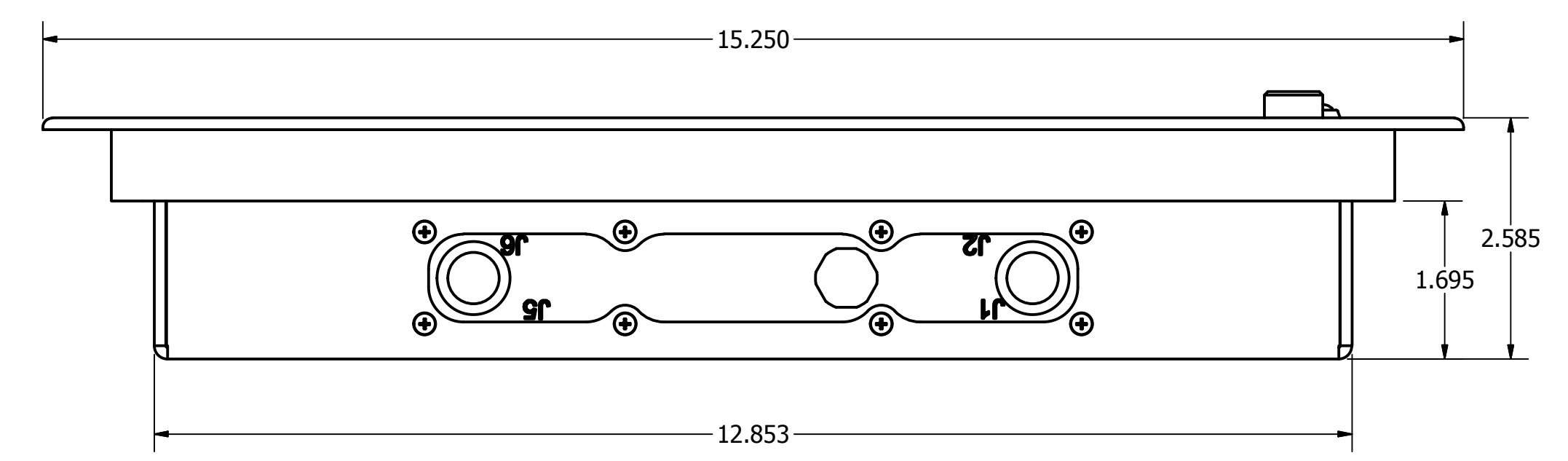
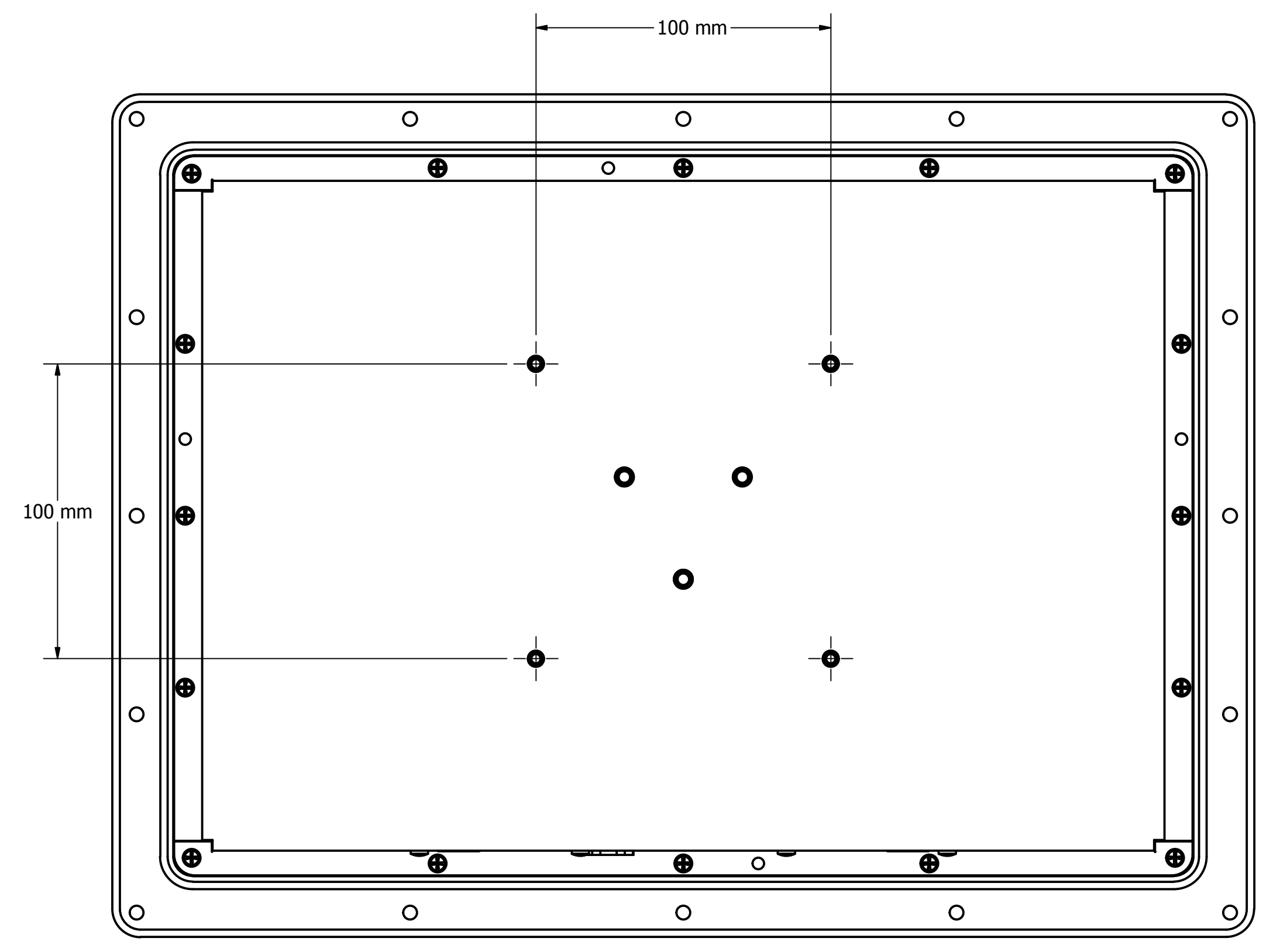
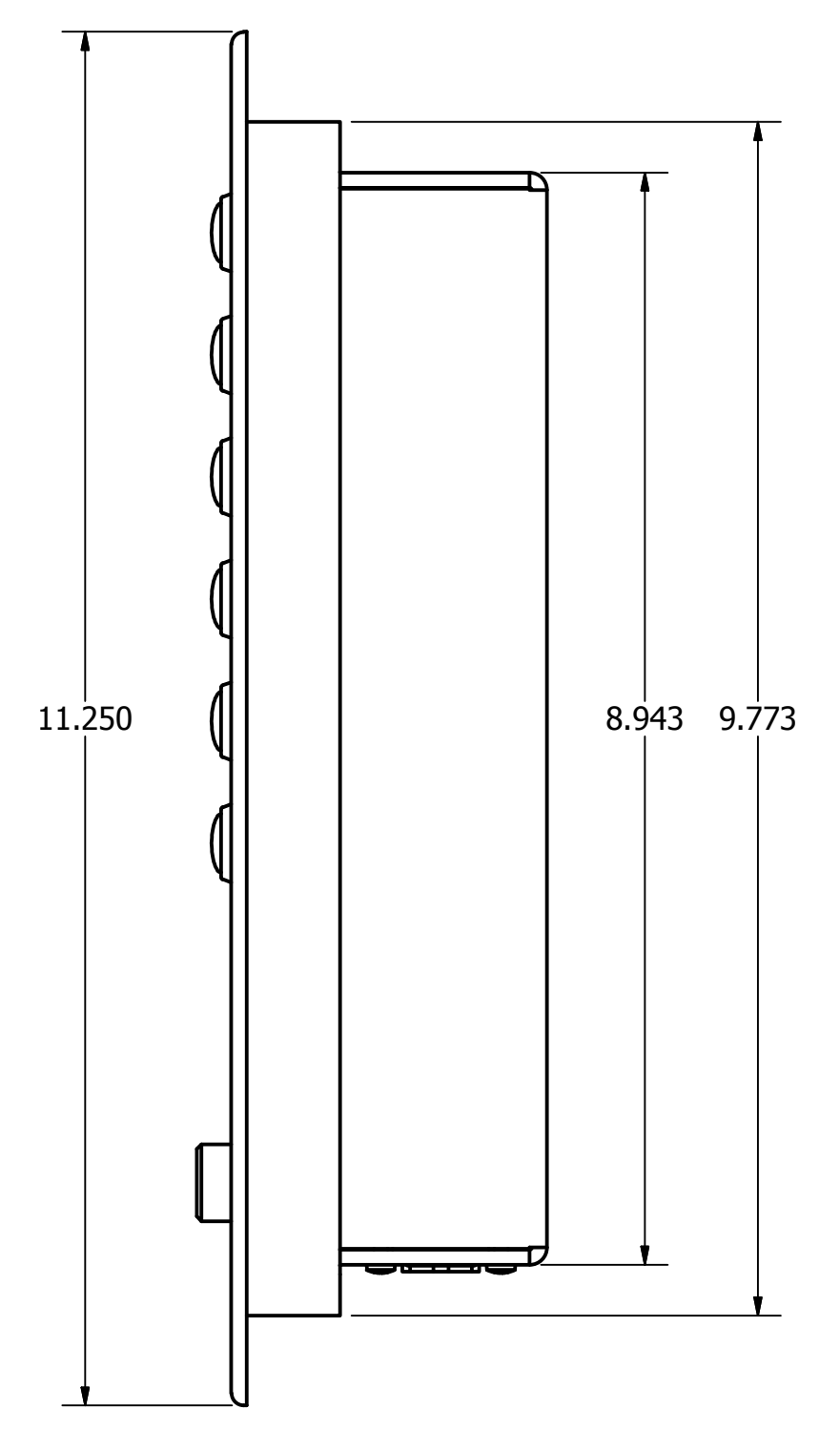
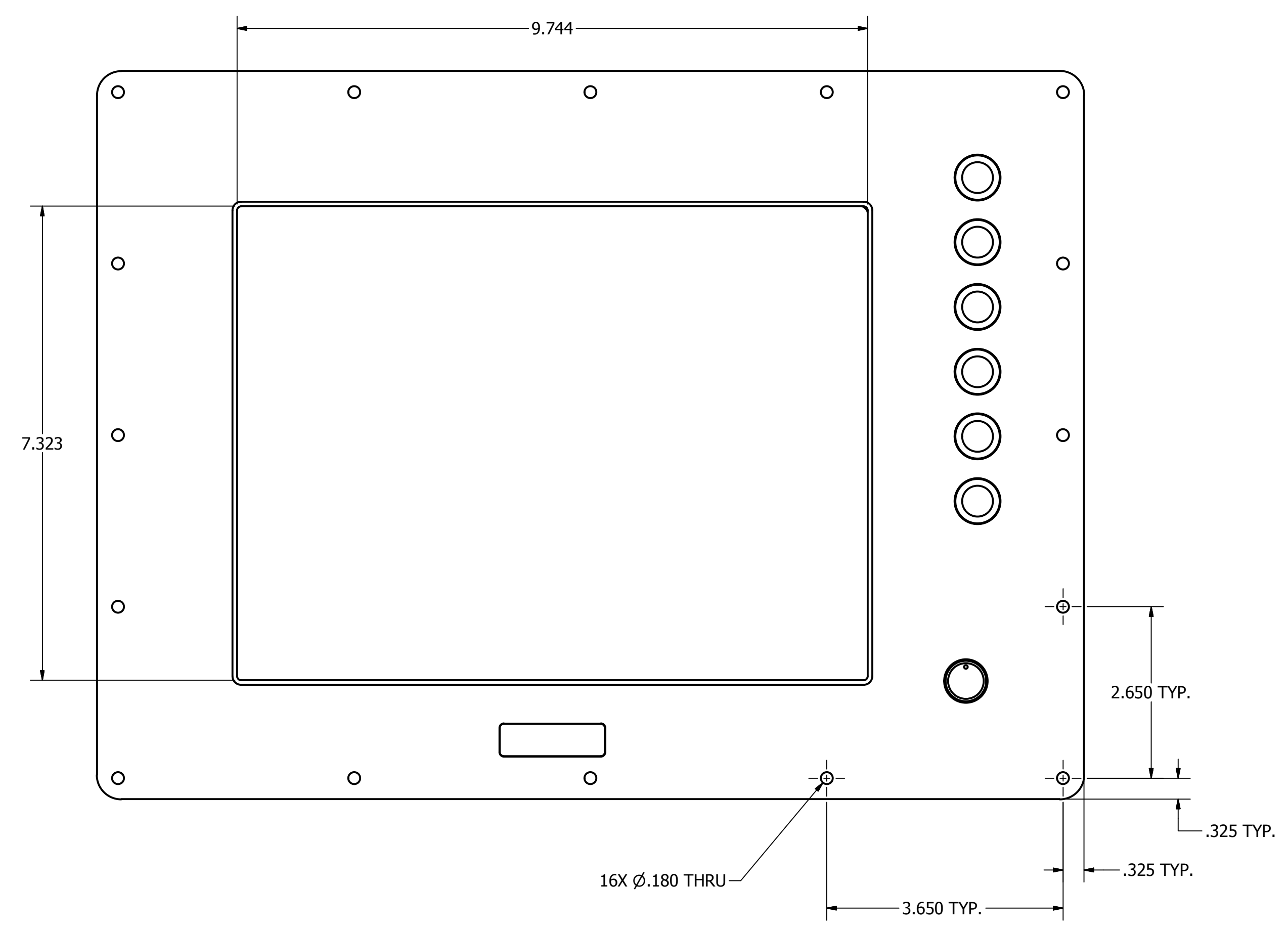

DRAWN	ACarlton	5/26/2010	VARTECH SYSTEMS			
CHECKED						
QA			TITLE			
MFG			OUTLINE DRAWING, AW, 12.1"			
APPROVED			SIZE	TOLERANCES:	DWG NO	REV
USED ON	MATERIAL:		D	.XX = .01 .XXX = .005	482-0072-00	1
APPLICATION			FINISH:			SHEET 1 OF 1